

**BATTERY MANUFACTURER  
WORLDWIDE TECH SUPPORT**

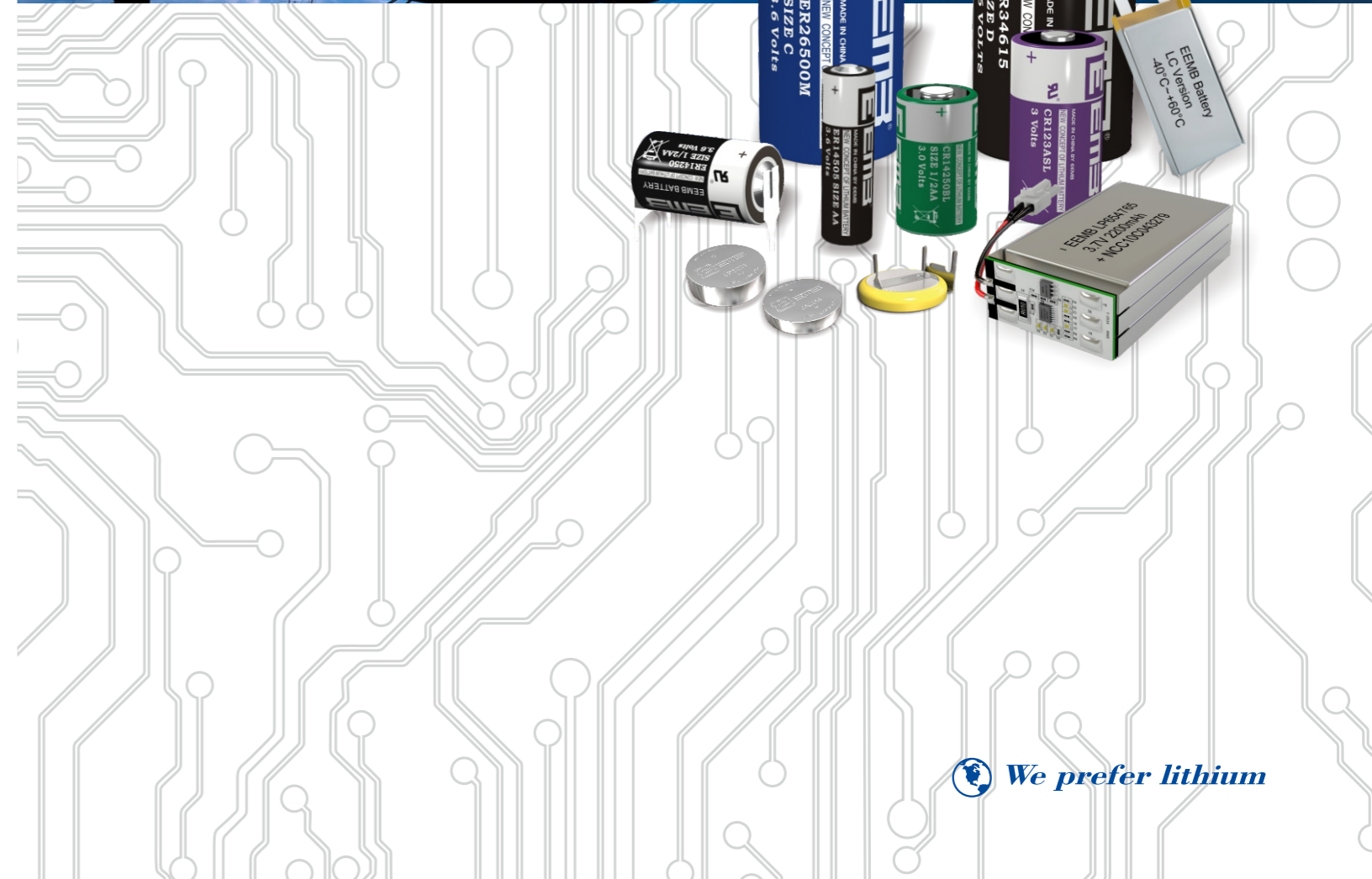

**LITHIUM BATTERY**

Tel: +86-755-83022275 Fax: +86-755-83021966 E-mail: global@eemb.com

<http://eemb.com>



# CONTENTS



## Company Profile

### EEMB Battery

EEMB is specialized in the production of Primary Lithium Battery and Rechargeable Lithium Battery since 1995. Because of our strong sales network and great customer service in the industry, our products have reached world wide.

Our company emphasizes the application of the latest technology and systematic management. We are dedicated to provide products and service up to and beyond customers' expectation in a timely and reliable manner.

Our highly qualified staff, modernized management, and international sales concept are the core of the company. We firmly believe in letting our employees self-manage and everyone's contribution will be highly valued. The idea of "Quality, Innovation, Sincerity and Service" runs through the enterprise culture.

Li-SOCl <sub>2</sub> Battery	1~4
Li-SO <sub>2</sub> Battery	5
Li-MnO <sub>2</sub> Battery	6~10
Li-Polymer Battery	11~15
LiFePO <sub>4</sub> Battery	16~18
Li-ion Battery	19~21
Ni-MH Battery	22~24
Terminals	25~27
Battery Holder	28

# Li-SOCl<sub>2</sub> Battery Energy & High Power Type

## Cell Constructions



Energy Type

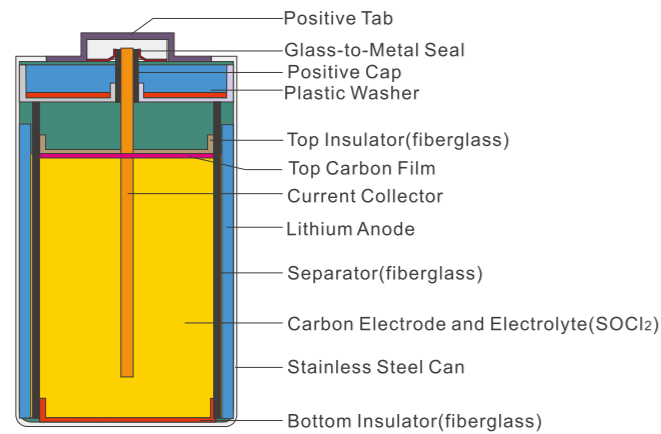

High Power Type

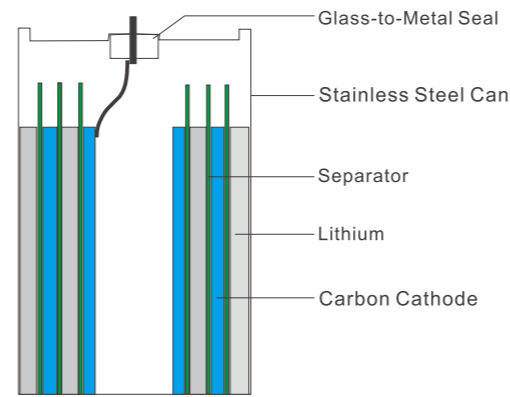

## Main Features

- ▶ Wide Temperature Range.
- ▶ Superior Shelf Life and Reliability: over 15 years at room temperature and self-discharge rate is less than 1% of its nominal capacity per year.
- ▶ Energy type is bobbin structure and best suit for low current discharge. It may require depassivation before medium currents can be delivered.
- ▶ High power type is spiral structure and best suit for high current discharge for both continuous & pulse currents. It may require depassivation before medium currents can be delivered.

## Applications

- ✓ Medical Instruments, Cash Registers
- ✓ Alarms and security wireless devices
- ✓ Tracking devices
- ✓ Electronic Meters (Water, Gas, Electricity)
- ✓ Automotive telematics
- ✓ Professional electronics
- ✓ Marine / oceanographic equipment

## Energy Type(Cylindrical)

Model	Size	Nominal Voltage (V)	Nominal Capacity (mAh)	Standard Discharge Current (mA)	Max. Discharge Current(mA)		Dimension (mm)		Approx. Weight(g)
					Conts.	Pulse	Diameter	Height	
ER10250	—	3.6	400	0.5	5	10	10.5	25.0	4.0
ER10450	AAA	3.6	800	0.5	25	60	10.5	45.0	9.0
ER13150	—	3.6	450	0.5	10	20	13.5	15.0	7.0
ER13170	—	3.6	500	0.5	10	20	13.5	17.0	7.0
ER14250	1/2AA	3.6	1200	0.5	40	80	14.5	25.8	10.0
ER14335	2/3AA	3.6	1650	1.3	50	100	14.5	33.5	13.0
ER14505	AA	3.6	2400	2.0	100	200	14.5	50.5	20.0
ER17335	2/3A	3.6	2100	2.0	100	200	17.0	33.5	20.0
ER17505	A	3.6	3400	3.0	120	200	17.0	50.5	24.0
ER18505	—	3.6	4000	2.0	120	200	18.5	50.5	30.0
ER20505	—	3.6	4400	3.0	120	250	20.0	50.5	35.0
ER26500	C	3.6	9000	2.0	200	400	26.0	50.0	53.0
ER34615	D	3.6	19000	2.0	230	500	34.0	61.5	115.0
ER341245	DD	3.6	36000	2.0	420	500	34.0	124.5	200.0
ER9V	—	10.8	1200	0.5	40	80	16.9 x 26.0 x 48.8		40.0

## Energy Type(Button)

ER2450	—	3.6	500	0.5	8.0	20	24.5	5.5	9.0
--------	---	-----	-----	-----	-----	----	------	-----	-----

## Computer Back-up

ER14250-CB	1/2AA	3.6	1200	0.5	40	80	17.0	28.8	13.0
ER14505-CB	AA	3.6	2400	2.0	100	200	16.6	54.5	22.0
ER26500-CB	C	3.6	9000	2.0	200	400	30.0 x 30.0 x 56.0		55.0

## High Power Type

Model	Size	Nominal Voltage (V)	Nominal Capacity (mAh)	Standard Discharge Current (mA)	Max. Discharge Current(mA)		Dimension (mm)		Approx. Weight(g)
					Conts.	Pulse	Diameter	Height	
ER14250M	1/2AA	3.6	750	4.0	120	250	14.5	25.2	11.0
ER14335M	2/3AA	3.6	1200	4.0	300	500	14.5	33.5	13.0
ER14505M	AA	3.6	1800	10.0	500	1000	14.5	50.5	22.0
ER17335M	2/3A	3.6	1700	10.0	500	1000	17.0	33.5	21.0
ER18505M	—	3.6	3200	10.0	1000	2000	18.5	50.5	30.0
ER20505M	—	3.6	3600	10.0	1000	2000	20.0	50.5	35.0
ER26500M	C	3.6	6500	10.0	1000	2000	26.0	50.0	57.0
ER34615M	D	3.6	14000	10.0	2000	3000	34.0	61.5	118.0

Operation Temperature: -55 ~ + 85°C, Self-Discharge Rate: < 1%/year at room temperature.

### Electrical Performance Curve

#### Energy Type

(For ER14250 Typical)

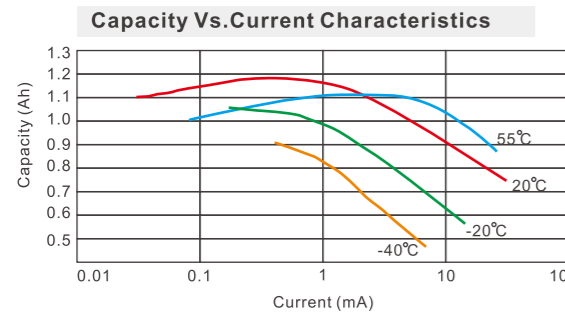
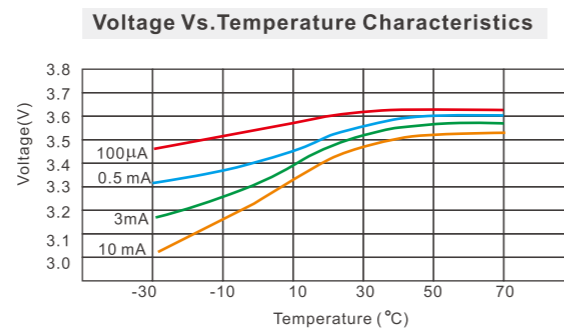
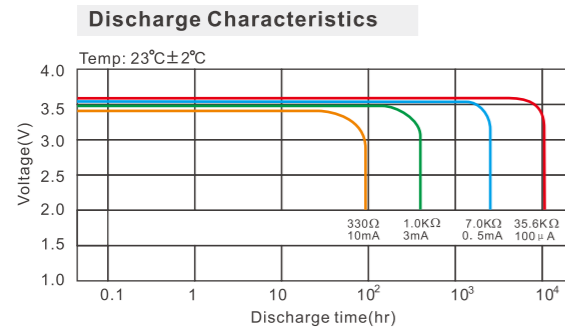

#### High Power Type

(For ER34615M Typical)

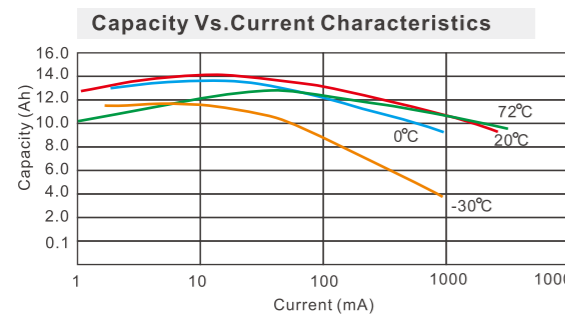
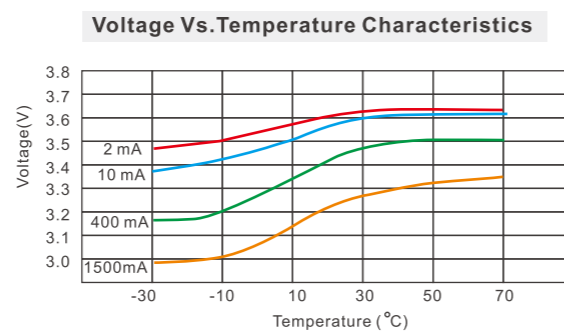
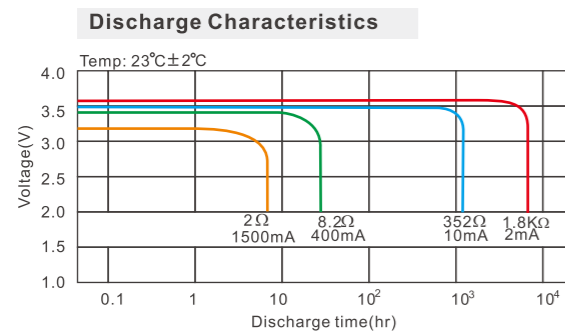

## Li-SOCl<sub>2</sub> Battery High Temperature Type



### High Temperature Type

Model	Size	Nominal Voltage (V)	Nominal Capacity (mAh)	Standard Discharge Current (mA)	Max. Discharge Current (mA)		Dimension (mm)		Approx. Weight (g)
					Conts.	Pulse	Diameter	Height	
ER14250S	1/2AA	3.6	600	50.0	50	100	14.5	25.2	10.0
ER14505S	AA	3.6	1800	50.0	100	200	14.5	50.5	20.0
ER26500S	C	3.6	5500	50.0	150	300	26.0	50.0	55.0
ER34615S	D	3.6	12000	100.0	170	350	34.0	61.5	108.0
ER341245S	DD	3.6	25000	200.0	400	800	34.0	124.5	220.0
ER17335S	2/3AA	3.6	1200	—	80	—	17.0	33.5	19.0

Operation Temperature: -20~ + 150°C, Self-Discharge Rate: ≤ 1%/year at room temperature.

### Main Features

- ▶ Extension of operating temperature range.
- ▶ Less loss in capacity.
- ▶ Superior shelf life and high reliability.
- ▶ Low self-discharge rate.

### Applications

- ✓ Physical detection and NC wells detection tool
- ✓ Data acquisition instrument
- ✓ Electronic testing instrument
- ✓ Aerospace equipment



# Li-SO<sub>2</sub> Battery



## Product Specification

Model	Size	Nominal Voltage (V)	Nominal Capacity (mAh)	Standard Discharge Current (mA)	Max. Discharge Current(mA)		Dimension (mm)		Approx. Weight(g)
					Conts.	Pulse	Diameter	Height	
LSS18505	—	2.9	2000	100	1500	2500	18.0	50.5	28
LSS26500	C	2.9	3700	100	2000	4000	26.0	50.0	48
LSS34615	D	2.9	7800	200	4000	6000	34.0	61.5	90

Operation Temperature: -55 ~ + 65°C, Self-Discharge Rate: 3%/year at room temperature.

### Main Features

- Wide Operation Temperature Range.
- Low Self-discharge: Less than 3% of capacity loss per year at room temperature.

### Applications

- Mainly used for electronic measuring instruments
- Low-temperature instruments and meters
- Oil exploration
- Passive probes
- Data logger

# Battery Pack Remark: Customized design is available

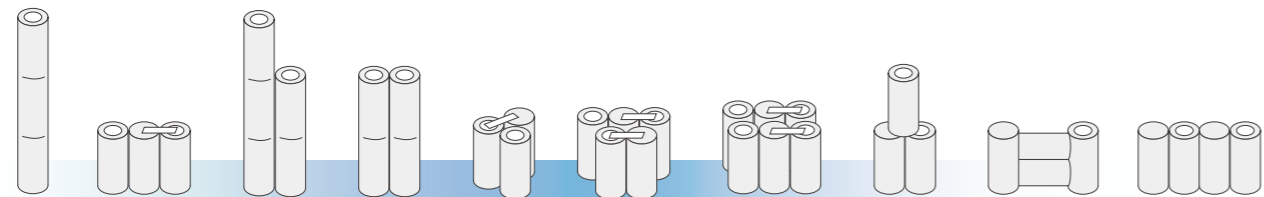

CODE:A CODE:B CODE:G CODE:S CODE:T CODE:W CODE:Y CODE:E CODE:U CODE:M

# Li-MnO<sub>2</sub> Cylindrical Battery

## Cell Constructions (Hermetically Glass to Metal Sealed)

### High Power Type

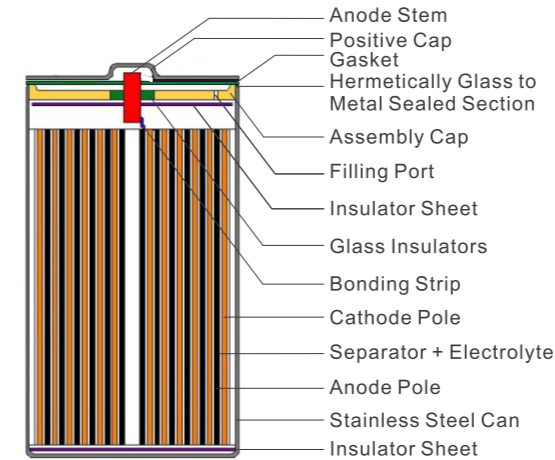

### High Capacity Type

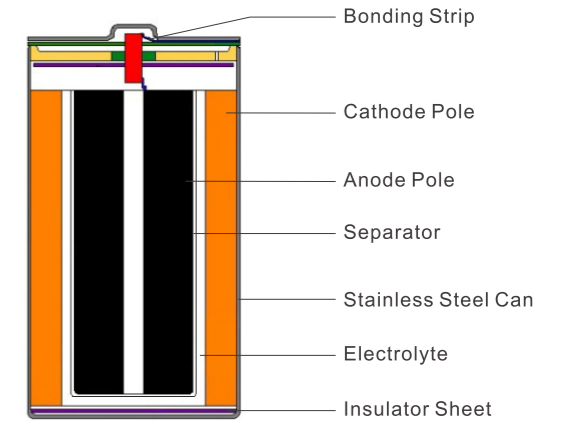

### Main Features

- High power type for high current discharge & High capacity type for low current discharge.
- Low self-discharge rate and long shelf life.
- Stable discharge characteristics.
- Superior leakage resistance.

### Applications

- Fully automatic cameras
- DSC, Lighting, Radios
- Electronic locks
- Medical equipment
- Water, gas and electricity meters
- Memory backup power sources



### High Power Spiral Structure

Model	Size	Nominal Voltage (V)	Nominal Capacity (mAh)	Standard Discharge Current (mA)	Max. Discharge Current(mA)		Dimension (mm)		Approx. Weight(g)
					Conts.	Pulse	Diameter	Height	
CR14250SL	1/2AA	3.0	600	1.0	500	1000	14.5	25.0	10.0
CR14335SL	2/3AA	3.0	900	1.0	800	1500	14.5	33.5	14.0
CR14505SL	AA	3.0	1500	1.0	1000	2000	14.5	50.5	21.0
CR2SL	—	3.0	800	1.0	800	1500	15.5	27.0	13.0
CR123ASL	—	3.0	1500	1.0	1500	3000	17.0	34.5	20.0
CR17335SL	2/3A	3.0	1500	1.0	1500	3000	17.0	34.5	20.0
CR17450SL	—	3.0	2200	1.0	1500	3000	17.0	45.0	26.0
CR17505SL	A	3.0	2500	1.0	1500	3000	17.0	50.5	30.0
CR18505SL	—	3.0	2800	1.0	1500	3000	18.5	50.5	35.0
CR26500SL	C	3.0	5000	10.0	2000	3000	26.0	50.0	62.0
CR34615SL	D	3.0	11000	10.0	2000	3000	34.0	61.5	125.0
2CR5SL	—	6.0	1500	1.0	1500	3000	34.0X17.0X45.0		43.0
CR-P2SL	—	6.0	1500	1.0	1500	3000	35.8X19.5X34.8		42.0

Operation Temperature:-40 ~ +85°C, Self-Discharge Rate: 1%/year at room temperature.



### High Capacity Bobbin Structure

Model	Size	Nominal Voltage (V)	Nominal Capacity (mAh)	Standard Discharge Current (mA)	Max. Discharge Current(mA)		Dimension (mm)		Approx. Weight(g)
					Conts.	Pulse	Diameter	Height	
CR10450BL	—	3.0	850	0.5	7	70	10.0	45.0	10.0
CR14250BL	1/2AA	3.0	900	1.0	7	70	14.5	25.0	11.0
CR14335BL	2/3AA	3.0	1100	0.5	8	80	14.5	33.5	16.0
CR14505BL	AA	3.0	1800	1.0	10	100	14.5	50.5	22.0
CR17335BL	2/3A	3.0	1800	1.0	10	100	17.0	34.5	22.0
CR17450BL	—	3.0	2400	1.0	15	150	17.0	45.0	28.0
CR18505BL	—	3.0	3000	1.0	20	200	18.5	50.5	38.0
CR34615BL	D	3.0	14000	2.0	80	200	34.0	61.5	135.0

Operation Temperature:-40 ~ +85°C, Self-Discharge Rate: 1%/year at room temperature.

## Electrical Performance Characteristics

### High Power Type

(For CR14505SL Typical)

#### Discharge Characteristics

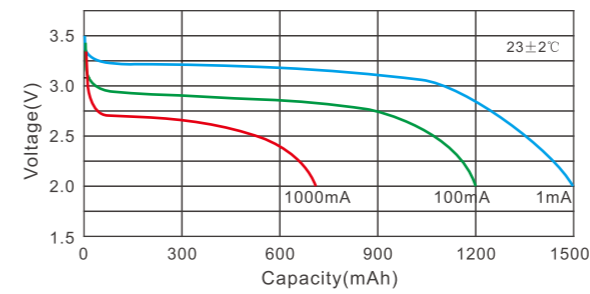

#### Voltage Vs. Temperature Characteristics

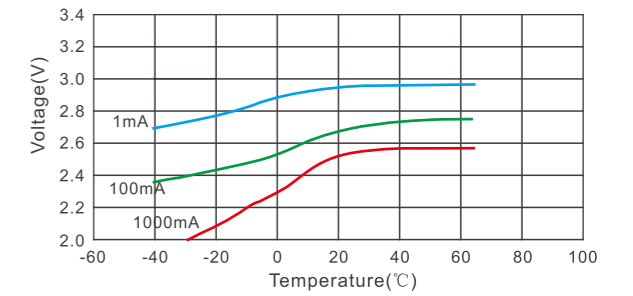

#### New Battery Vs. Stock Battery

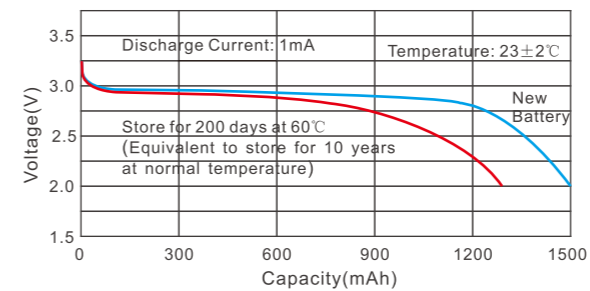

### High Capacity Type

(For CR14505BL Typical)

#### Discharge Characteristics

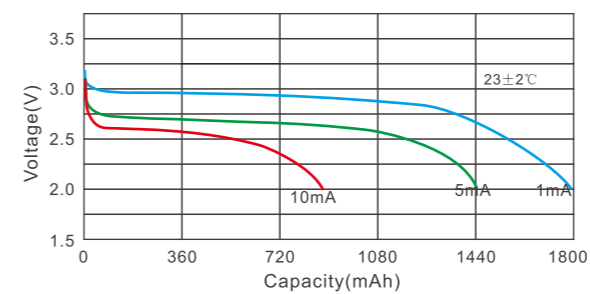

#### Voltage Vs. Temperature Characteristics

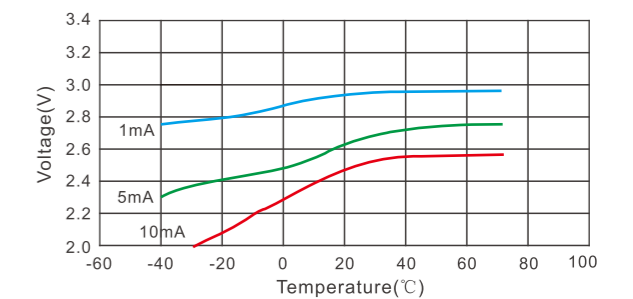

#### New Battery Vs. Stock Battery

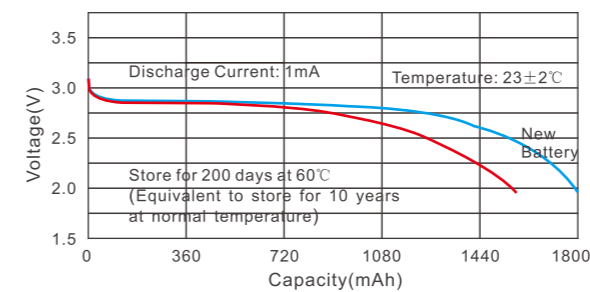

# Li-MnO<sub>2</sub> Button Battery

## Cell Constructions

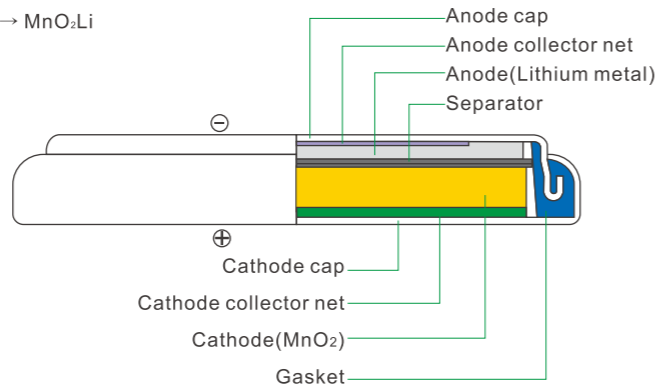
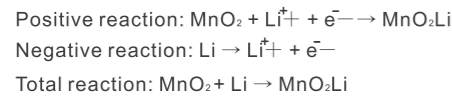

## Main Features

- ▶ Low self-discharge rate and long shelf life.  
Self-discharge rate: less than 3% a year at room temperature.
- ▶ Stable discharge characteristics.
- ▶ Superior high-rate pulse discharge characteristics.
- ▶ Applicable in a wide temperature range.
- ▶ Superior leakage resistance.

## Applications

- ✓ Watches (digital and analog)
- ✓ Calculators
- ✓ Electronic notebooks
- ✓ Electronic keys for automobiles
- ✓ Card radios
- ✓ PC cards
- ✓ LED-related
- ✓ Medical equipment
- ✓ Memory backup power source



## Standard Type

Model	Nominal Voltage (V)	Nominal Capacity (mAh)	Standard Discharge Current (mA)	Dimension (mm)		Approx. Weight (g)
				Diameter	Height	
CR1220	3.0	40	0.2	12.5	2.0	0.8
CR1225	3.0	50	0.2	12.5	2.5	1.0
CR1616	3.0	50	0.1	16.0	1.6	1.2
CR1620	3.0	70	0.1	16.0	2.0	1.3
CR1632	3.0	120	0.1	16.0	3.2	1.6
CR2016	3.0	85	0.2	20.0	1.6	1.7
CR2025	3.0	150	0.4	20.0	2.5	2.4
CR2032	3.0	210	0.2	20.0	3.2	3.0
CR2330	3.0	250	0.4	23.0	3.0	4.0
CR2354	3.0	500	0.4	23.0	5.4	5.7
CR2430	3.0	270	0.4	24.5	3.0	4.3
CR2450	3.0	550	0.4	24.5	5.0	6.2
CR2477	3.0	1000	2.0	24.5	7.7	9.5
CR3032	3.0	500	0.4	30.0	3.2	6.8

Operation Temperature: -20 ~ +60°C, Self-Discharge Rate: < 3%/year at room temperature.

## High Temperature Type

CR1225S	3.0	45	0.05	12.5	2.5	0.9
CR1632S	3.0	110	0.1	16.0	3.2	2.0
CR2025S	3.0	150	0.2	20.0	2.5	2.5
CR2032S	3.0	210	0.2	20.0	3.2	3.0
CR2450S	3.0	550	0.2	24.5	5.0	6.8

Operation Temperature: -40 ~ +125°C, Self-Discharge Rate: < 5%/year at room temperature.

## Low Temperature Type

CR1632L	3.0	120	0.2	16.0	3.2	2.0
CR2032L	3.0	210	0.2	20.0	3.2	3.0
CR2450L	3.0	580	0.4	24.5	5.0	6.8

Operation Temperature: -40 ~ +70°C, Self-Discharge rate: < 5%/year at room temperature.

## High Capacity Type

CR2032H	3.0	230	0.2	20.0	3.2	3.0
CR2450H	3.0	600	0.4	24.5	5.0	6.5

Operation Temperature: -20 ~ +60°C, Self-Discharge Rate: < 3%/year at room temperature.

## Electrical Performance Curve (For CR2025 Typical)

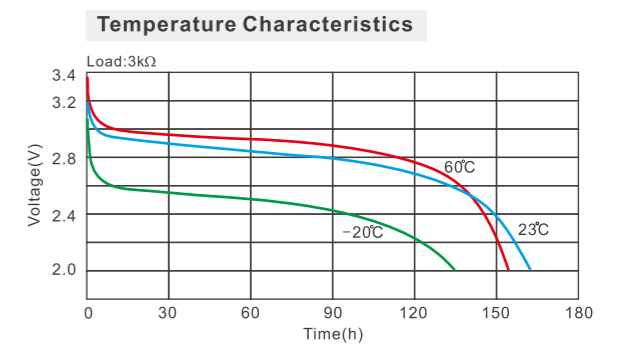
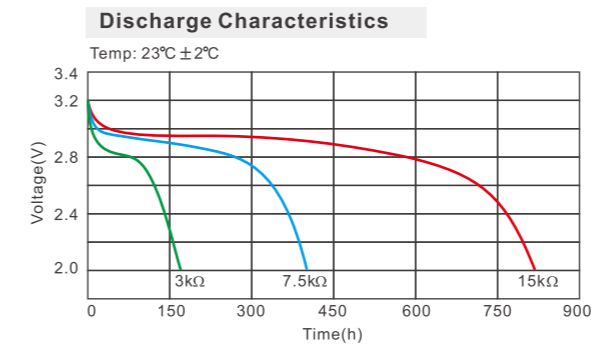

# Li-Polymer Battery Rechargeable

## » Lithium Ion Polymer Battery Theory

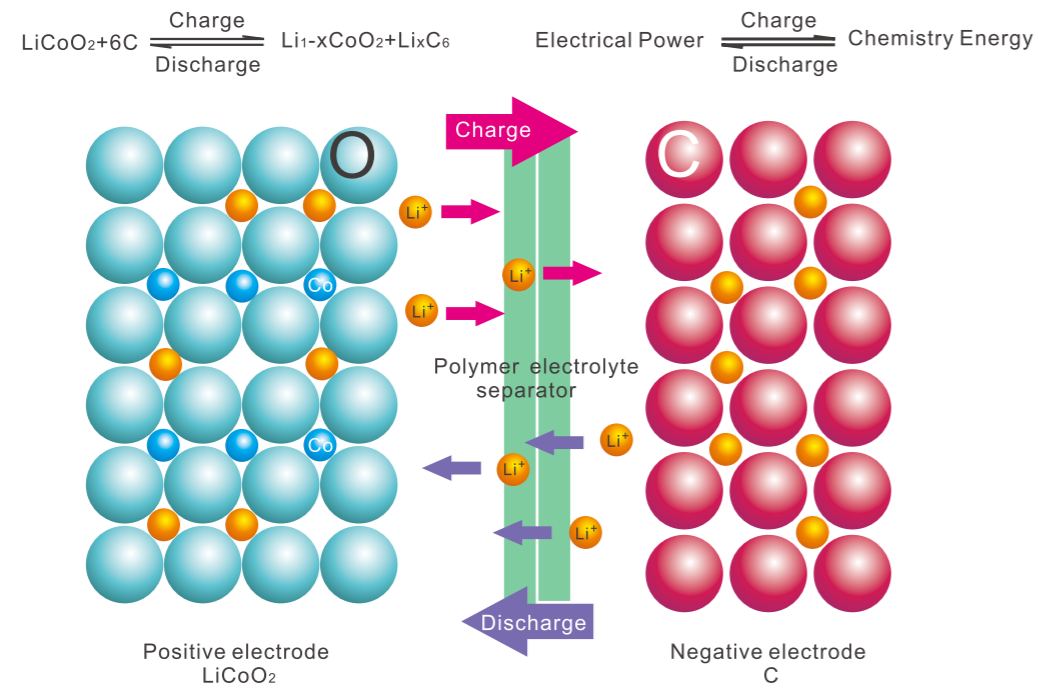

## » Main Features

- » Excellent high power discharge
- » Extremely safe
- » Long cycle life
- » Design flexible
- » Lighter & thinner
- » Low self-discharge rate
- » Environmentally friendly

## » Applications

- » R/C Flying Models, Racing Car
- » Portable DVD, MP3, MP4
- » Bluetooth, Wireless Devices
- » GPS
- » PDA, Digital Camera
- » Electric Bicycle, Power Tools

## » Cell Constructions

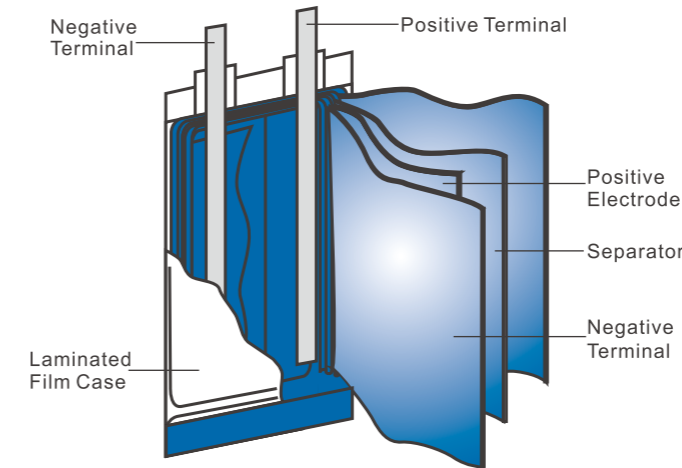

- Positive: Pre-lithiated transition metal oxides, such as lithium cobalt oxide, lithium manganese oxide and etc.
- Negative: carbon materials with special structures, such as soft carbon, hard carbon graphite and graphite carbon fibers and etc.
- Electrolyte: organic solvents and lithium salt solution.
- Separator: porous polypropylene (PP) or polyethylene(PE)
- Packaging materials: aluminum composite film, steel casing or aluminum casing.

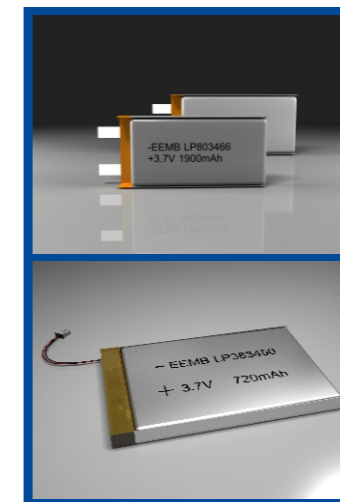



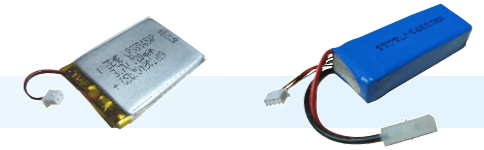

**Product Specification**

Standard Version							
Model	Nominal Voltage (V)	Nominal Capacity(mAh)		Dimension (mm)			Approx. Weight(g)
		Typical	Minimum	Thickness	Width	Height	
LP451124	3.7	65	60	4.8	11.5	25	1.3
LP401230	3.7	100	90	4.3	12.5	31	2.0
LP501230	3.7	140	130	5.3	12.5	31	2.8
LP301730	3.7	100	90	3.5	17.5	31	2.0
LP401730	3.7	150	140	4.3	17.5	31	3.0
LP601730	3.7	250	230	6.3	17.5	31	5.0
LP401745	3.7	250	220	4.3	17.5	46	5.0
LP402030	3.7	190	170	4.3	20.5	31	4.0
LP452030	3.7	230	210	4.8	20.5	31	4.6
LP502030	3.7	250	230	5.3	20.5	31	5.0
LP222036	3.7	95	90	2.5	20.5	37	1.9
LP402036	3.7	220	200	4.3	20.5	37	4.4
LP502036	3.7	310	290	5.3	20.5	37	6.2
LP552036	3.7	360	340	5.8	20.5	37	7.2
LP852040	3.7	620	580	8.8	20.5	41	12.4
LP822245	3.7	750	700	8.5	22.5	46	15.0
LP652438	3.7	540	510	6.8	24.5	39	10.8
LP752438	3.7	600	550	7.8	24.5	39	12.0
LP603026	3.7	420	380	6.3	30.5	27	8.4
LP653042	3.7	820	770	6.8	30.5	43	16.4
LP453048	3.7	710	660	4.8	30.5	49	14.2
LP503048	3.7	750	700	5.3	30.5	49	15.0
LP603048	3.7	900	850	6.3	30.5	49	18.0
LP703048	3.7	1000	950	7.3	30.5	49	20.0
LP803048	3.7	1200	1100	8.3	30.5	49	24.0
LP883048	3.7	1300	1200	9.1	30.5	49	26.0
LP803090	3.7	2300	2200	8.3	30.5	91	46.0
LP883090	3.7	2500	2400	9.1	30.5	91	50.0
LP403448	3.7	620	580	4.3	34.5	49	12.4
LP503448	3.7	880	830	5.3	34.5	49	17.6
LP603448	3.7	1050	950	6.3	34.5	49	21.0
LP803448	3.7	1350	1250	8.3	34.5	49	27.0
LP293450	3.7	450	420	3.2	34.5	51	9.0
LP323450	3.7	550	520	3.5	34.5	51	11.0
LP383450	3.7	720	680	4.1	34.5	51	14.4
LP483450	3.7	800	750	5.1	34.5	51	16.0
LP503450	3.7	1000	950	5.3	34.5	51	20.0
LP533450	3.7	900	850	5.6	34.5	51	18.0
LP603450	3.7	1000	950	6.3	34.5	51	20.0
LP703450	3.7	1250	1150	7.3	34.5	51	25.0
LP803450	3.7	1400	1300	8.3	34.5	51	28.0
LP953450	3.7	1800	1700	9.8	34.5	51	36.0
LP963450	3.7	1800	1700	9.9	34.5	51	36.0
LP243452	3.7	350	330	2.7	34.5	55	7.0
LP383454	3.7	750	700	4.1	34.5	55	15.0
LP103454	3.7	2000	1900	10.3	34.5	55	40.0
LP603560	3.7	1300	1200	6.3	35.5	61	26.0
LP503759	3.7	1250	1150	5.3	37.5	60	25.0

Standard Version							
Model	Nominal Voltage (V)	Nominal Capacity(mAh)		Dimension (mm)			Approx. Weight(g)
		Typical	Minimum	Thickness	Width	Height	
LP583759	3.7	1350	1250	6.1	37.5	60	27.0
LP404261	3.7	1000	950	4.3	42.5	62	20.0
LP754261	3.7	2000	1900	7.8	42.5	62	40.0
LP704374	3.7	2200	2100	7.3	43.5	75	44.0
LP704765	3.7	2300	2200	7.3	47.5	66	46.0
LP804765	3.7	2500	2400	8.3	47.5	66	50.0
LP884765	3.7	3000	2800	9.1	47.5	66	60.0
LP385085	3.7	1600	1500	4.1	50.5	86	32.0
LP505085	3.7	2300	2200	5.3	50.5	86	46.0
LP705085	3.7	3100	2900	7.3	50.5	86	62.0
LP9051109	3.7	5500	5200	9.3	51.5	110	110.0
LP9551119	3.7	6800	6500	9.8	51.5	120	136.0
LP555255	3.7	1650	1550	5.8	52.5	56	33.0
LP305590	3.7	1450	1350	3.5	55.5	91	29.0
LP385590	3.7	1800	1700	4.1	55.5	91	36.0
LP505590	3.7	2800	2700	5.3	55.5	91	56.0
LP545590	3.7	2900	2700	5.7	55.5	91	58.0
LP605590	3.7	3400	3200	6.3	55.5	91	68.0
LP61100100	3.7	6800	6400	6.4	100.5	101	136.0
LP38103122	3.7	4000	3800	4.1	103.5	123	80.0
LP70103122	3.7	8700	8200	7.3	103.5	123	174.0

Operation Temperature: -20 ~ + 60°C.

\*Thickness can be adjusted while the length and width remain the same.

**Electrical Performance Curve (For LP703048 Typical)**

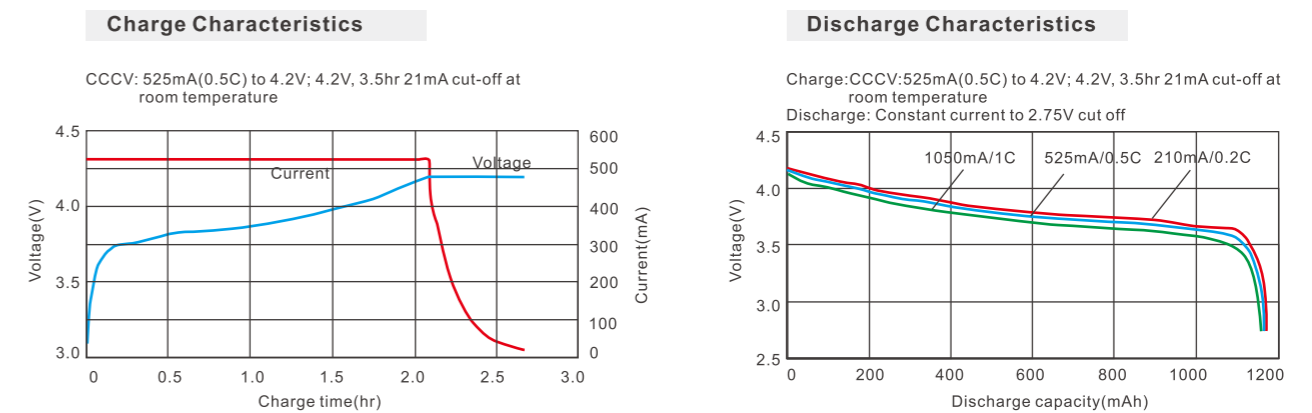

# LiFePO<sub>4</sub> Battery Rechargeable

## Cell Constructions

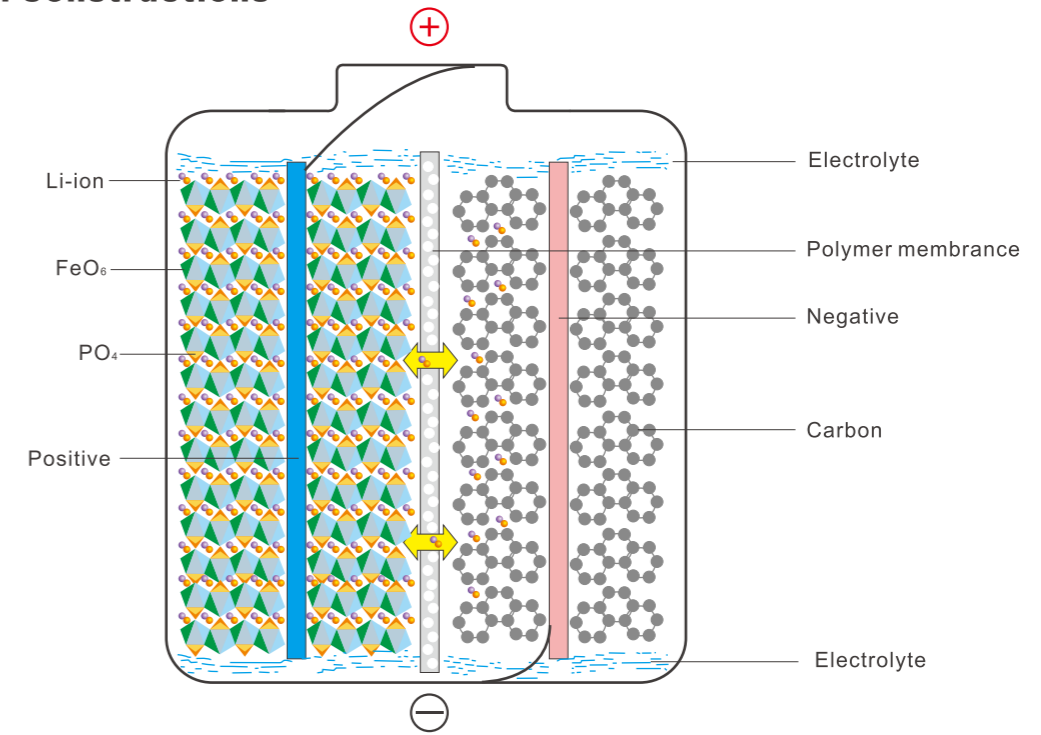

## Lithium Iron Phosphate Battery Theory

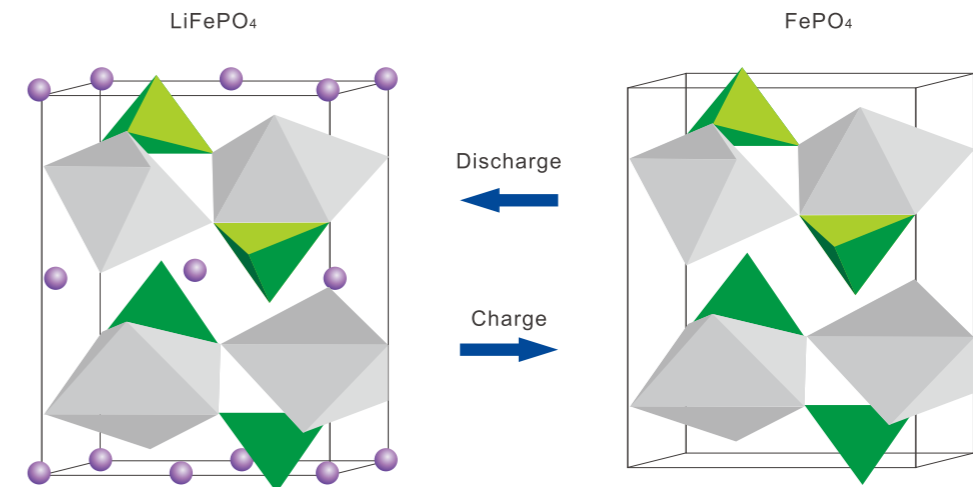

High Rate Discharge Version							
Model	Nominal Voltage (V)	Nominal Capacity(mAh)		Dimension (mm)			Approx. Weight(g)
		Typical	Minimum	Thickness	Width	Height	
LP452030HA	3.7	160	150	4.5	20	30	3.2
LP353048HA	3.7	250	220	3.5	30	48	5.0
LP403048HA	3.7	450	420	4.0	30	48	9.0
LP423048HA	3.7	430	400	4.2	30	48	28.5
LP503048HA	3.7	550	520	5.0	30	48	11.0
LP703048HA	3.7	800	700	7.0	30	48	19.0
LP883090HA	3.7	2000	1800	8.8	30	90	45.5
LP553448HA	3.7	800	750	5.5	34	48	16.0
LP603450HA	3.7	880	800	6.0	34	50	13.5
LP803454HA	3.7	1400	1300	8.0	34	54	28.0
LP803560HA	3.7	1250	1150	8.0	35	60	30.5
LP503759HA	3.7	850	800	5.0	37	59	22.0
LP451218HB	3.7	40	30	4.5	12	18	1.1
LP555590HB	3.7	2300	2100	5.5	55	90	54.5
LP723048HB	3.7	850	800	7.2	30	48	20.0
LP532030HB	3.7	200	190	5.3	20	30	5.2
LP551522HB	3.7	100	90	5.5	15	22	2.0
LP681723HB	3.7	150	130	6.8	17	23	3.0
LP481530HC	3.7	120	110	4.8	15	30	3.3
LP753496HC	3.7	2200	2100	7.5	34	96	48.0
LP3834106HD	3.7	1200	1100	3.8	34	106	29.0
LP8242125HD	3.7	4000	3800	8.2	42	125	80.0
LP9245150HD	3.7	5550	5400	9.2	45	150	111.0
LP1042126HD	3.7	5000	4800	10.0	42	126	35.0
LP7842125HD	3.7	3500	3300	7.8	42	125	70.0

Operation Temperature: -20 ~ + 60°C.

- ※ HA: 5 C-10 C Continuous Discharge
- ※ HB: 10 C-15 C Continuous Discharge
- ※ HC: 15 C-20 C Continuous Discharge
- ※ HD: 20 C Continuous Discharge

High & Low Temperature Version							
Model	Nominal Voltage (V)	Nominal Capacity(mAh)		Dimension (mm)			Approx. Weight(g)
		Typical	Minimum	Thickness	Width	Height	
LP383454LC	3.7	720	670	3.8	34	54	14.4
LP603048LC	3.7	900	850	6.0	30	48	18.0
LP963450LC	3.7	1800	1700	9.6	34	50	36.0
LP103450LC	3.7	1850	1800	10.0	34	50	37.0
LP505597LC	3.7	3100	2900	5.0	55	97	62.0
LP103454LC	3.7	2000	1950	10.0	34	54	40.0
LP102040TB	3.7	800	750	10.0	20	40	16.0

LC: Operation Temperature -40 ~ 55°C. TB: Operation Temperature -20 ~ 70°C.

\*Thickness can be adjusted while the length and width remain the same.

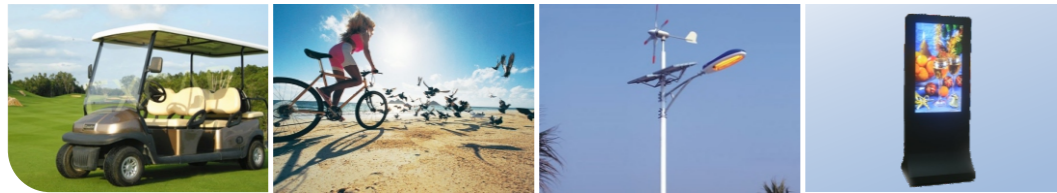

### Electrical Performance Characteristics

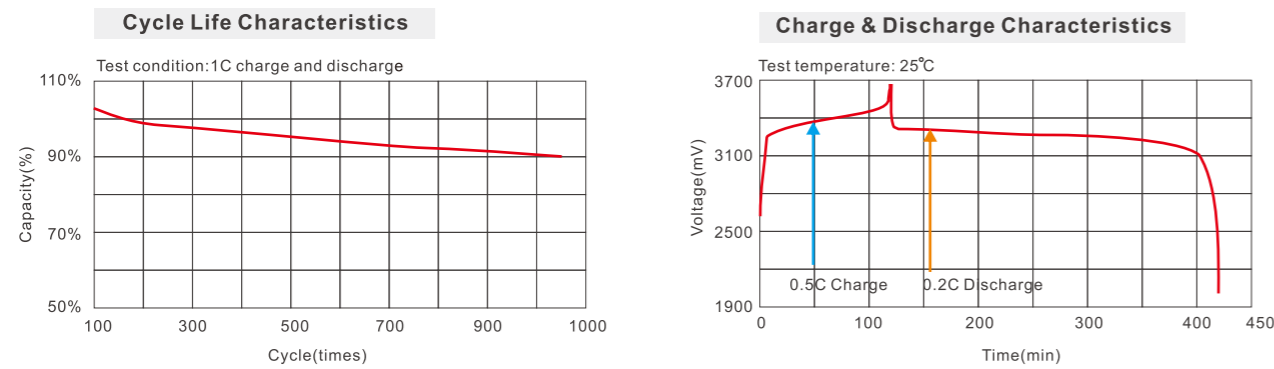

### Main Features

- ▶ **Long cycle life: more than 2000 times**  
Charge and discharge at 1C, 80% capacity retention after 2000 cycles.
- ▶ **High safety**
- ▶ **Excellent charging and discharging performance**
- ▶ **High discharge rate up to 10C**
- ▶ **Environmentally friendly**  
No poisonous or hazardous materials, no pollution to the environment.

### Applications

- ✓ **Light Electric Vehicles**  
E-bike, Golf cart, Minitype panel scooter, Forklift, Cleaning vehicle, Electric-wheel chair.
- ✓ **Energy Storage Equipment for Solar Energy and Wind Energy**
- ✓ **Electric Tools**  
Electric drill, Electric saw, Electric lawn mower, UPS, Emergency lamp, Caution light and miner's light (Best safety)
- ✓ **Electric Vehicles**  
Tourist bus and hybrid vehicle.
- ✓ **Mobile Telecommunication Base Station**
- ✓ **Emergency Power Supply System**

### Cell

Model	Nominal Voltage (V)	Nominal Capacity (mAh)	Dimension(mm) max.			Approx. Weight(g)
			Thickness	Width	Height	
LP903395F	3.2	1800	9.3	33.5	97	45.0
LP584374F	3.2	1200	6.1	43.5	76	30.0
LP904374F	3.2	2100	9.3	43.5	76	52.5
LP7851119F	3.2	3700	8.1	51.5	121	92.5
LP9051119F	3.2	4300	9.3	51.5	121	107.5
LP7053140F	3.2	4000	7.3	53.5	142	100.0
LP5267220F	3.2	6000	5.5	67.5	222	150.0
LP1167220F	3.2	10000	11.3	67.5	222	250.0
LP7568130F	3.2	5000	7.8	68.5	132	125.0
LP9590120F	3.2	7500	9.8	90.5	122	187.5
LP8867220F	3.2	10000	9.1	67.5	226	250.0
LP60100100F	3.2	4500	6.3	100.5	102	112.5
LP90100160F	3.2	10000	9.3	100.5	162	250.0
LP75103122F	3.2	7500	7.8	103.5	124	187.5
LP13120200F	3.2	25000	14.0	122.0	208	660.0

Models Listed are all UL Certificated and have ready mold.

### Pack

Model	Nominal Voltage (V)	Nominal Capacity (Ah)	Cell Dimension(mm) max.			Approx. Pack Weight (kg)
			Thickness	Width	Height	
LP8867220F-4S	12	10	9.1	67.5	226	1.5
LP8867220F-2P4S	12	20	9.1	67.5	226	2.5
LP8867220F-4P4S	12	40	9.1	67.5	226	4.5
LP8867220F-8S	24	10	9.1	67.5	226	2.5
LP8867220F-2P8S	24	20	9.1	67.5	226	4.5
LP8867220F-6P16S	48	60	9.1	67.5	226	25.0
LP8867220F-2P20S	60	20	9.1	67.5	226	11.0
LP8867220F-4P20S	60	40	9.1	67.5	226	22.0

### Module

Model	Nominal Voltage(V)	Nominal (Ah)	Dimension(mm) max.			Approx. Weight(kg)
			Thickness	Width	Height	
3.2V, 40Ah	3.2	40	60	95	280	2.00
3.2V, 80Ah	3.2	80	60	165	280	3.25
3.2V, 100Ah	3.2	100	60	165	280	3.75

### Cylindrical

Model	Nominal Voltage(V)	Nominal Capacity (mAh)	Internal Impedance (mΩ)	Dimension(mm) max.		Approx. Weight(g)
				Diameter	Height	
LIP14500	3.2	600	≤40	14.0	50.0	17
LIP18500	3.2	1000	≤60	18.0	50.0	37
LIP18650	3.2	1100	≤20	18.0	65.0	40
LIP18650	3.2	1400	≤60	18.0	65.0	40
LIP26650	3.2	3200	≤50	26.0	65.0	85

Operation Temperature: -10 ~ + 60°C.

# Li-ion Battery Rechargeable

## Cell Constructions and Theory

### Cylindrical Type Battery

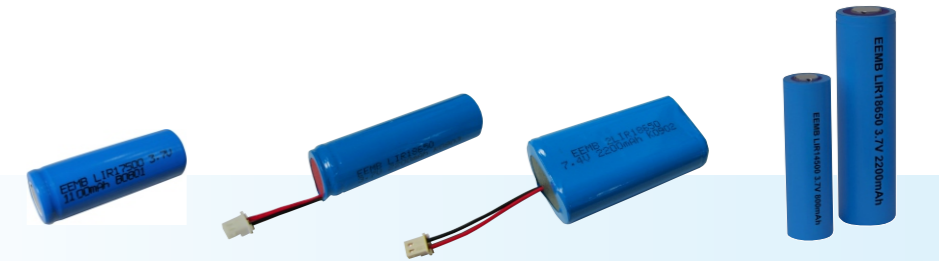
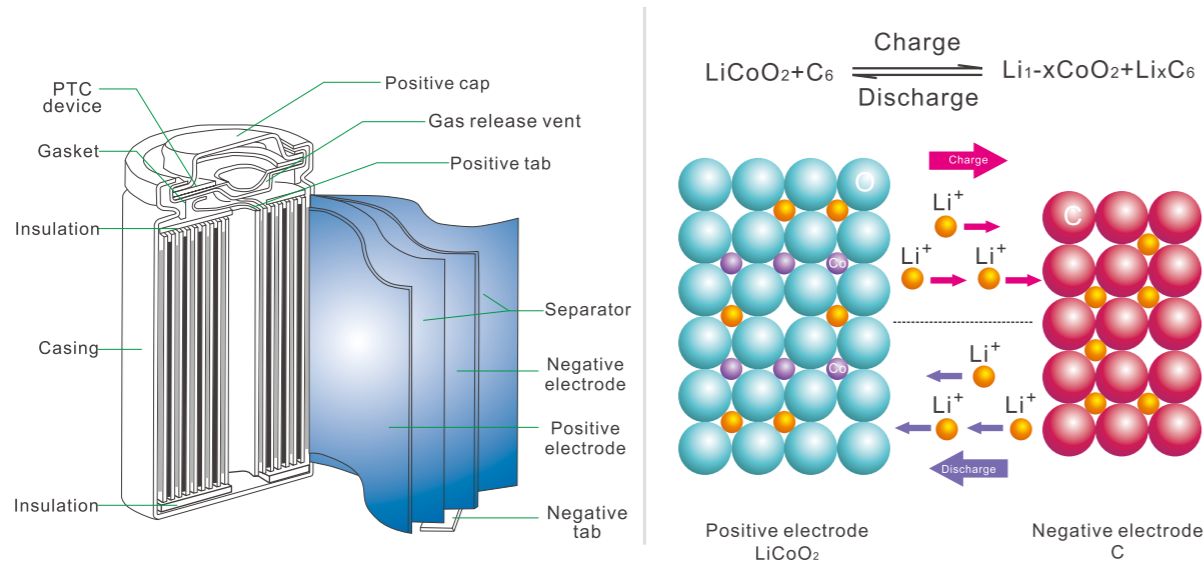

### Cylindrical Type

Model	Nominal Voltage (V)	Nominal Capacity (mAh)	Internal Impedance (mΩ)	Dimension (mm)		Approx. Weight(g)
				Diameter	Height	
LIR10440	3.7	300	≤110	10.0	44.0	12.0
LIR14500	3.7	750	≤80	14.0	50.0	20.0
LIR14500	3.7	800	≤80	14.0	50.0	20.0
LIR17500	3.7	1100	≤80	17.0	50.0	29.0
LIR18500	3.7	1300	≤70	18.0	50.0	33.0
LIR18500	3.7	1400	≤70	18.0	50.0	33.0
LIR18650	3.7	2000	≤60	18.0	65.0	48.0
LIR18650	3.7	2200	≤60	18.0	65.0	48.0
LIR18650	3.7	2600	≤60	18.0	65.0	48.0
LIR18650	3.7	3000	≤60	18.0	65.0	48.0

### Prismatic Type

Model	Nominal Voltage (V)	Nominal Capacity (mAh)	Internal Impedance (mΩ)	Dimension (mm)			Approx. Weight(g)
				Thickness	Width	Length	
LIR103450A	3.7	1800	≤60	10.0	34.0	50.0	35.5
LIR043048A	3.7	600	≤250	4.8	31.0	52.0	14.1
LIR523443A	3.7	880	≤80	5.5	34.0	43.0	18.1

\*Battery pack can be customized according to customer's requirements.

## Main Features

- Compact and slim**  
 Its high energy density helps design smaller and lighter equipment such as notebooks which consume higher power.
- Long operating time**  
 Its graphite negative electrode enables the battery pack to operate equipment for a long time with stable platform voltage.

## Applications

- Tracking units
- Monitoring units
- Communication devices
- Electronic instruments
- Audio visual equipment
- Laptop computers
- Wearable electronics devices
- Digital cameras
- Office automation
- PDA and handy terminals





# Ni-MH Battery Rechargeable

## Cell Constructions

### Cylindrical Type Battery

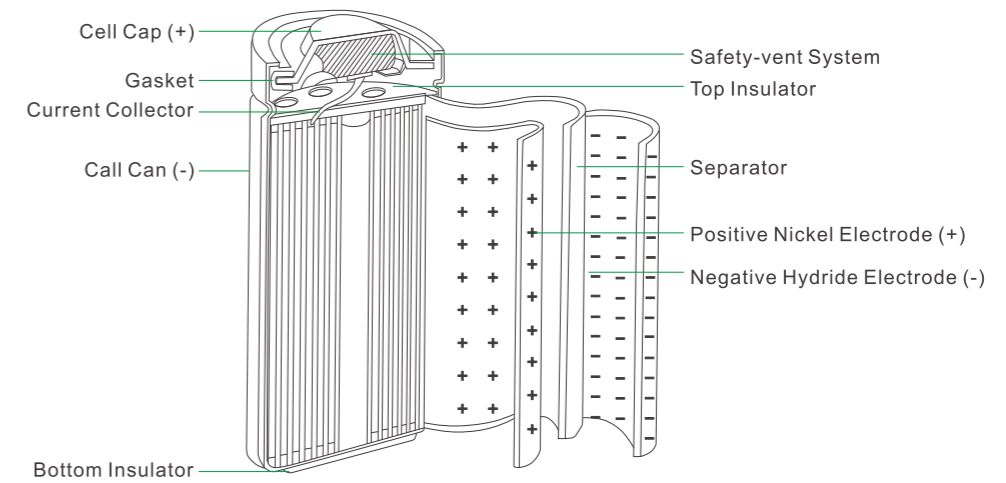

## Main Features

- ▶ Excellent discharge characteristics
- ▶ Green power
- ▶ High energy density
- ▶ Long shelf life
- ▶ Cycle life equivalent to 500 charge and discharge cycles
- ▶ Rapid charge in approx. 1.2 hours

## Applications

- ✔ Communication devices, such as: cordless telephone, mobile phone, interphone.
- ✔ Audio and video equipments, such as portable camcorder, Walkman, MD, DVD, TV.
- ✔ Information devices, such as notebook, PDA, portable facsimile apparatus.
- ✔ Household appliances, such as electric shaver, electric toothbrush, massage device, portable vacuum cleaner.
- ✔ Metering instrument.
- ✔ Emergency light and security system.
- ✔ Electric toys.
- ✔ Electric tools.

### Button Type

Model	Nominal Voltage (V)	Nominal Capacity (mAh)	Recommended Current(mA)		Approx Dimension (mm)		Approx. Weight(g)
			Conts.	Pulse	Diameter	Height	
LIR1220	3.6	7±1	0.2CmA	0.5CmA	12.5	2.0	0.8
LIR1620	3.6	15±2			16.0	2.0	1.2
LIR1632	3.6	25±2			16.0	3.2	1.7
LIR2016	3.6	15±2			20.0	1.6	1.7
LIR2025	3.6	30±2			20.0	2.5	2.3
LIR2032	3.6	40±2		20.0	3.2	2.8	
LIR2430	3.6	55±5		1CmA	24.5	3.0	3.8
LIR2440	3.6	80±5			24.5	4.0	4.4
LIR2450	3.6	120±10			24.5	5.0	5.3
LIR2466	3.6	145±5			24.5	6.6	6.7
LIR2477	3.6	185±5	24.5		7.7	7.5	

### High Capacity Type

LIR1220H	3.6	11±1	0.2CmA	0.5CmA	12.5	2.0	1.8
LIR2016H	3.6	28±2			20.0	1.6	1.8
LIR2032H	3.6	70±2			20.0	3.2	3.2
LIR2450H	3.6	200±10			24.5	5.0	6.3
LIR1255	3.6	55±5			1CmA	12.5	5.5
LIR1648	3.6	70		16.0		4.8	2.8
LIR1655	3.6	100±5		16.1		5.5	2.8
LIR3032	3.6	180±10		30.0		3.2	7.3
LIR3048	3.6	280±10		30.0		4.8	9.3

Operation Temperature:-20 ~ + 60°C.





**Cylindrical Type**

Model	Size	Nominal Voltage (V)	Nominal Capacity (mAh)	Standard Charge		Fast Charge		Dimension(mm)		Approx. Weight(g)
				Current (mA)	Time (hrs)	Current (mA)	Time (mins)	Diameter	Height	
NH-1/3AAA180	1/3AAA	1.2	180	18	16	90	138	10.1	15.0	4.0
NH-1/3AAA200	1/3AAA	1.2	200	20	16	100	144	10.1	21.0	5.2
NH-2/3AAA300	1/3AAA	1.2	300	30	16	300	75	10.1	27.8	6.6
NH-AAA600	AAA	1.2	600	60	16	600	75	10.1	42.8	10.8
NH-AAA700	AAA	1.2	700	70	16	700	150	10.1	44.0	11.3
NH-AAA800-T	AAA	1.2	800	80	16	400	150	10.1	44.3	11.9
NH-AAA900-T	AAA	1.2	900	90	16	450	75	10.1	44.5	12.6
NH-1/2AA600	1/2AA	1.2	600	60	16	600	75	13.9	24.1	11.3
NH-2/3AA600	2/3AA	1.2	600	60	16	600	75	13.9	27.6	11.7
NH-4/5AA700	4/5AA	1.2	700	70	16	700	75	13.9	42.6	14.0
NH-4/5AA1100	4/5AA	1.2	1100	110	16	1100	75	13.9	42.6	19.2
NH-AA1000	AA	1.2	1000	100	16	1000	150	13.9	48.6	18.7
NH-AA1800	AA	1.2	1800	180	16	900	150	14.1	49.6	27.2
NH-AA2200	AA	1.2	2200	220	16	1100	150	14.1	50.3	28.5
NH-AA2300-T	AA	1.2	2300	230	16	1150	420	14.2	50.3	29.0
NH-AA2500-T	AA	1.2	2500	250	16	500	144	14.2	50.3	30.0
NH-A2200	A	1.2	2200	220	16	1100	144	16.6	49.7	35.5
NH-4/3A3700	4/3A	1.2	3700	370	16	1850	144	16.6	66.5	50.3
NH-4/3A3800	4/3A	1.2	3800	380	16	1900	150	16.6	66.5	52.3
NH-SC2200	SC	1.2	2200	220	16	1100	144	21.9	42.6	44.5
NH-SC2500	SC	1.2	2500	250	16	1250	150	21.9	42.6	48.5
NH-SC2800	SC	1.2	2800	280	16	1400	150	21.9	42.6	51.5
NH-SC3000	SC	1.2	3000	300	16	1500	150	21.9	42.6	53.5
NH-SC3300	SC	1.2	3300	330	16	1650	150	21.9	42.6	57.5
NH-SC3500	SC	1.2	3500	350	16	1750	150	22.2	43.1	59.5
NH-C2600	C	1.2	2600	260	16	1300	150	25.2	48.3	56.0
NH-C2800	C	1.2	2800	280	16	1400	144	25.2	48.3	58.0
NH-C3000	C	1.2	3000	300	16	1500	150	25.2	48.3	61.0
NH-C3500	C	1.2	3500	350	16	1750	150	25.2	48.3	70.0
NH-C4000	C	1.2	4000	400	16	2000	150	25.2	48.3	72.0
NH-C4500-T	C	1.2	4500	450	16	2250	150	25.2	50.2	80.5
NH-D5000	D	1.2	5000	500	16	2500	150	32.2	59.6	102.0
NH-D8000	D	1.2	8000	800	16	4000	150	32.2	59.6	136.5
NH-D9000-T	D	1.2	9000	900	16	4500	150	32.2	61.0	154.0
NH-F13000	F	1.2	13000	1300	16	2600	420	32.2	90.0	225.0
NH-F14000	F	1.2	14000	1400	16	2800	420	32.2	88.6	242.5

\*Remark: "T" stands for high cap.

**Prismatic Type**

Model	Nominal Voltage (V)	Nominal Capacity (mAh)	Standard Charge		Fast Charge		Dimension(mm)			Approx. Weight(g)
			Current (mA)	Time (hrs)	Current (mA)	Time (mins)	Length	Width	Thickness	
NH-9V160	8.4	160	16	16	30	420	27.0	17.5	48.5	33.0
NH-9V180	8.4	180	18	16	36	420	27.0	17.5	48.5	42.0
NH-9V200	8.4	200	20	16	40	420	27.0	17.5	48.5	42.0
NH-9V250	8.4	250	25	16	50	420	27.0	17.5	48.5	42.0

**Button Type**

Model	Nominal Voltage (V)	Nominal Capacity (mAh)	Standard Charge		Fast Charge		Dimension(mm)		Approx. Weight(g)
			Current (mA)	Time (hrs)	Current (mA)	Time (mins)	Diameter	Height	
NH-30H	1.2	40	4.0	14	8.0	6.0	11.7	5.3	1.8
NH-60H	1.2	80	8.0	14	16.0	6.0	15.25	6.2	3.5
NH-250H	1.2	280	28.0	14	56.0	6.0	25.25	7.45	12.0



# Available Terminals For button batteries

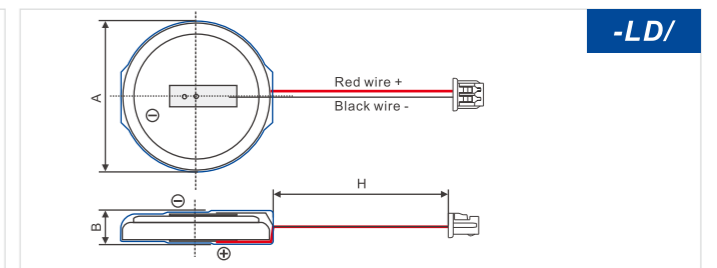
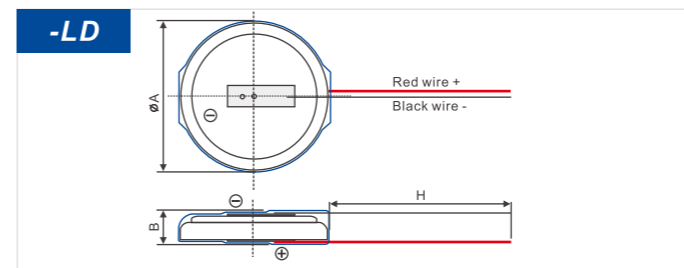
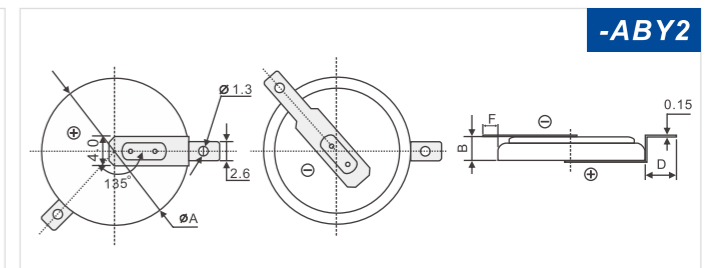
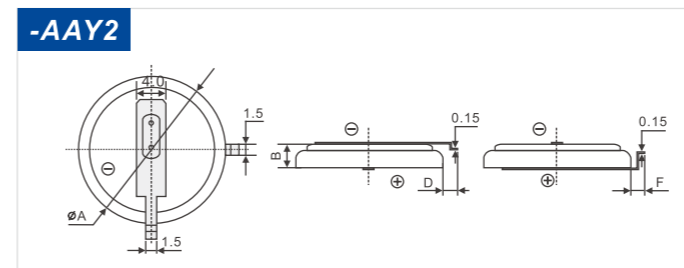
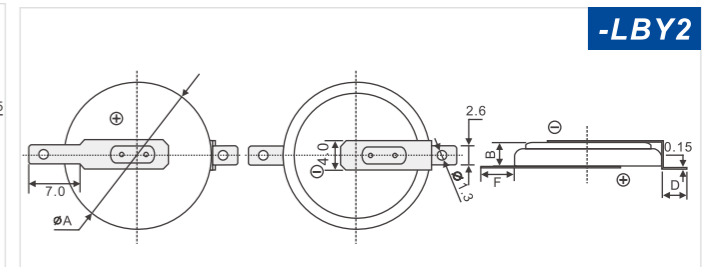
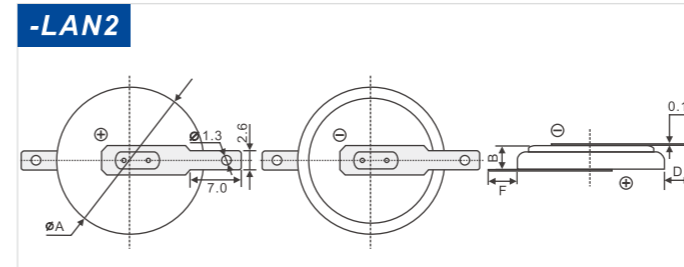
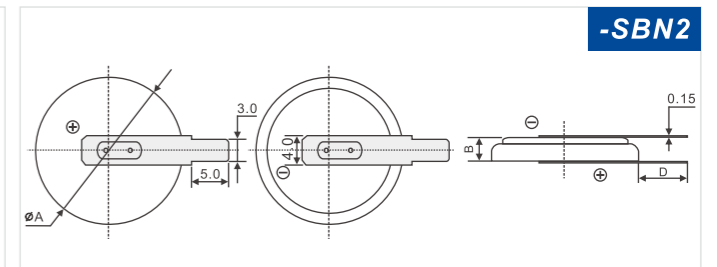
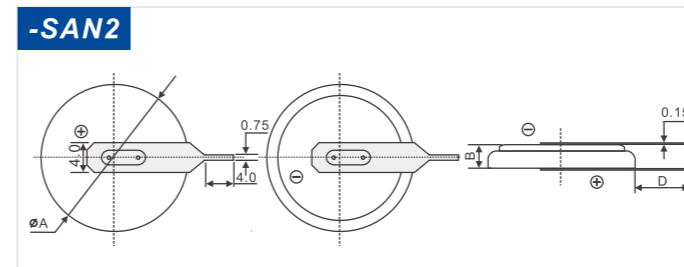
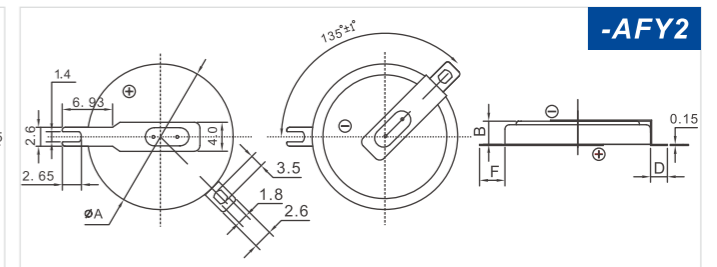
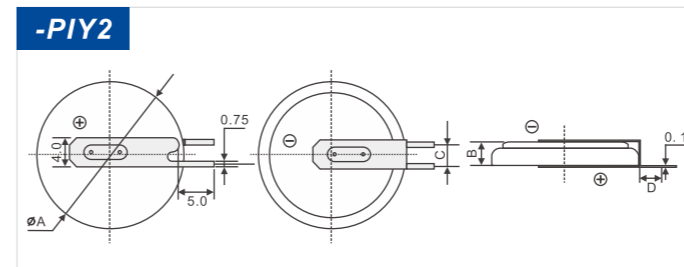
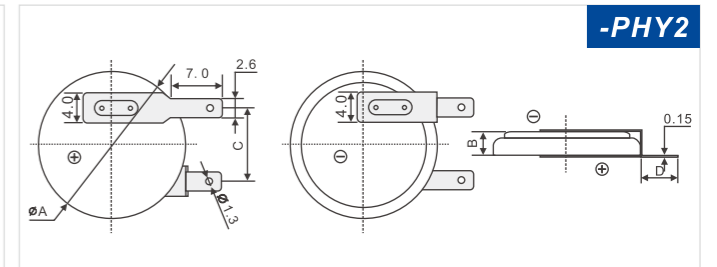
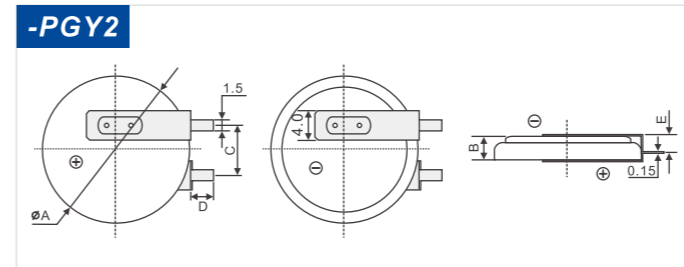
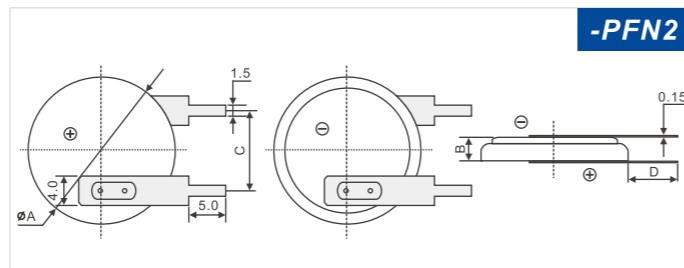
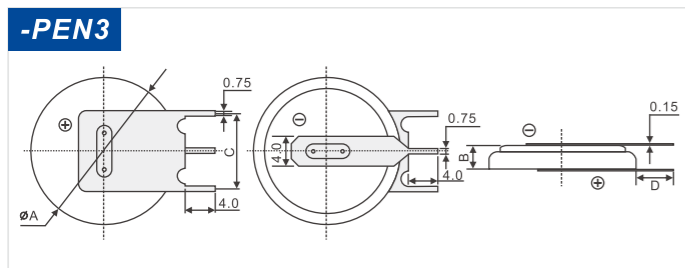
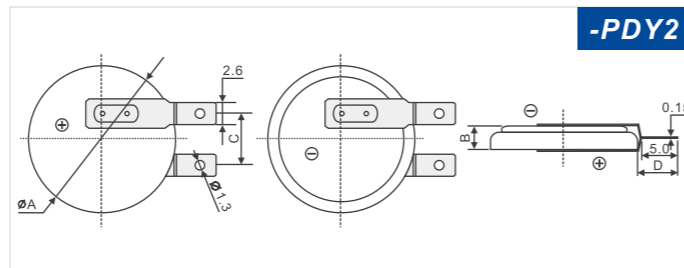
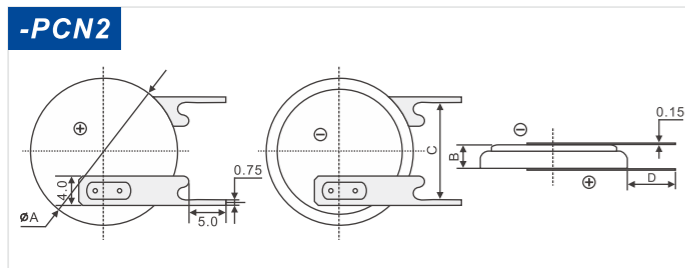
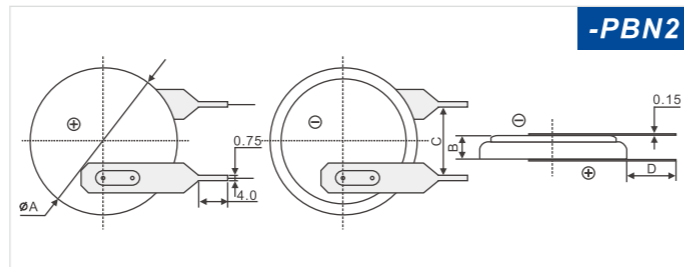
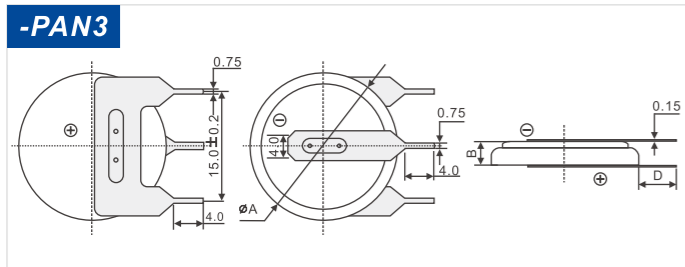
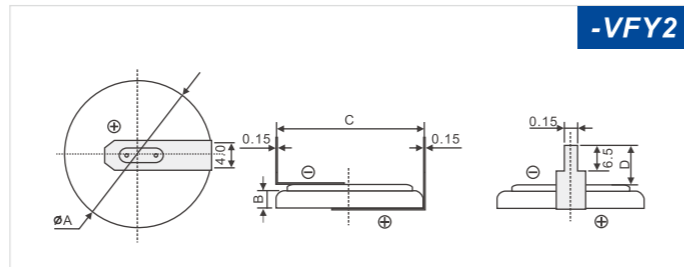
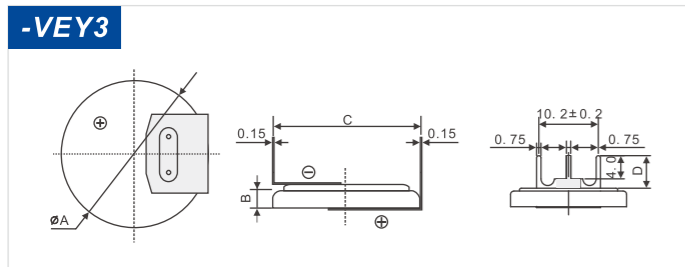
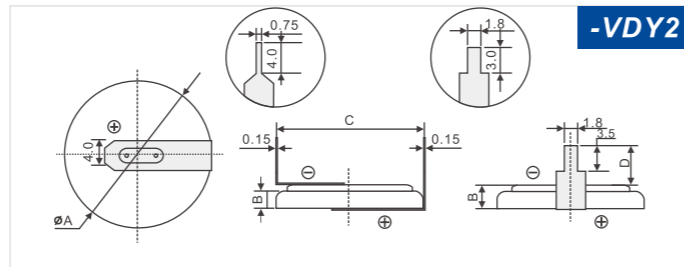
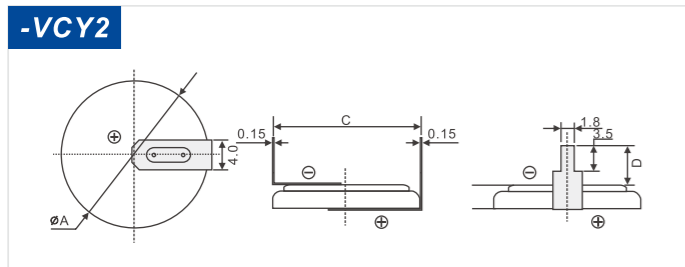
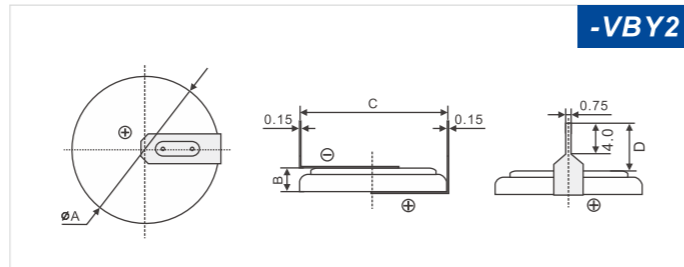
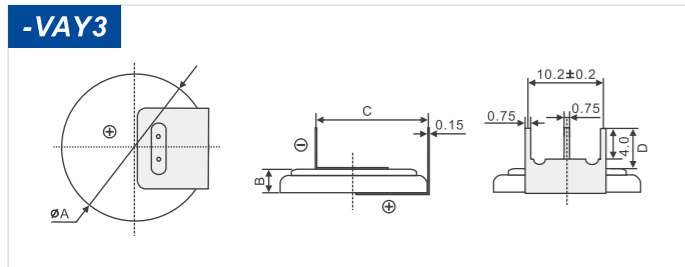

Remark: Customized design is available

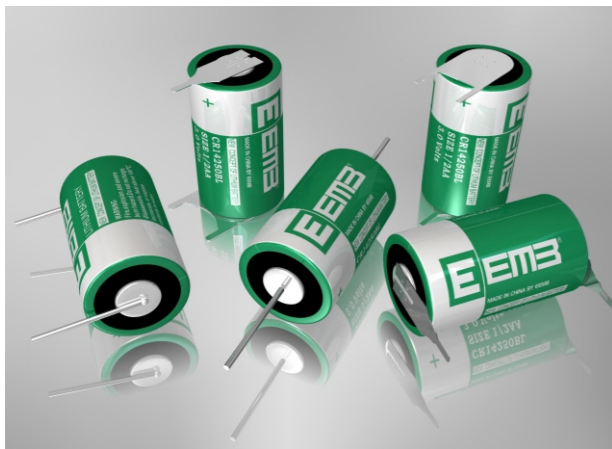
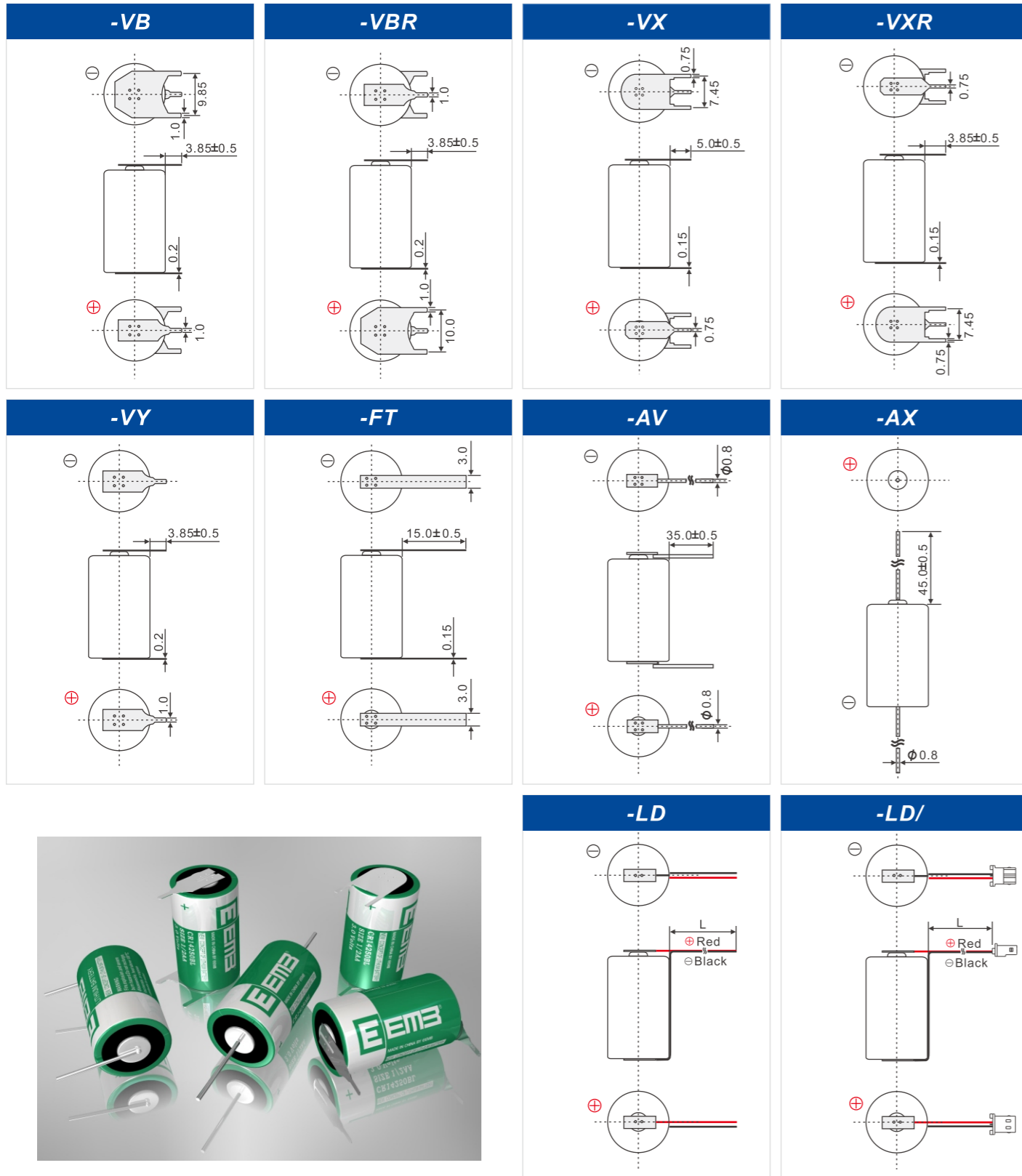

## Battery Holder



### For Button Batteries

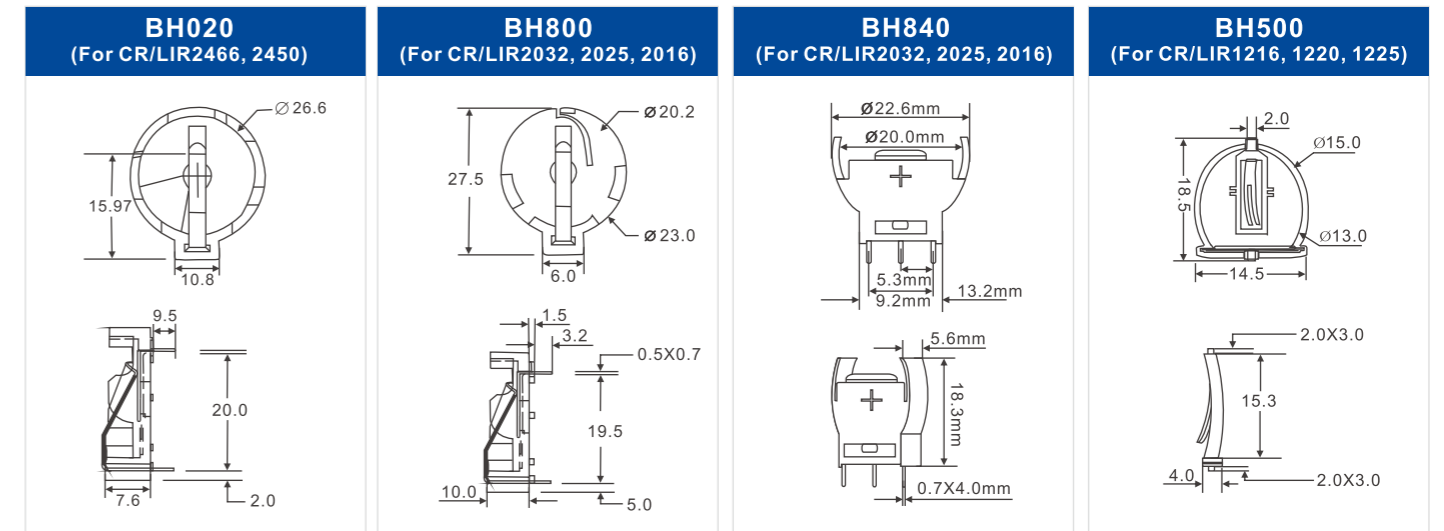

### For Cylindrical Batteries

